

➤ Instructions

Thule FreeRide 532



| | |
|---------------|--|
| EN | Roof-mounted bike carrier |
| DE | Dachfahrradträger |
| FR | Porte-vélo sur le toit |
| NL | Fietsdrager voor op het dak |
| IT | Portabicicleta da installare sul tetto |
| ES | Portabicicletas de techo |
| PT | Suporte para bicicleta para teto |
| SV | Takmonterad cykelhållare |
| DK | Tagmonteret cykelholder |
| NO | Takmonterte lasteholdere |
| FI | Katolle asennettava polkupyöräteline |
| ET | Katusela paigaldatav jalgrattahoidik |
| LV | Uz jumta uzstādāms velosipēdu turētājs |
| LT | Ant stogo tvirtinami dviračių laikikliai |
| PL | Bagażnik rowerowy montowany na dachu |
| RU | Устанавливаемое на крыше крепление для велосипедов |
| UK | Багажник для велосипедів, що монтується на даху |
| BG | Покривен багажник за велосипеди |
| CS | Nosič jízdních kol s montáží na střechu |
| SK | Nosič bicyklov s montážou na strechu |
| SL | Nosilec za kolesa |
| HR/BIH | Krovni nosač bicikla |

| | |
|-----------|--|
| RO | Suport pentru bicicletă montat pe pavilion |
| HU | Tetőre szerelhető kerékpártartó |
| EL | Σχάρα ποδηλάτου οροφής |
| TR | Araç üstüne bağlanan bisiklet taşıyıcı |
| | מגש אופניים המונח על הסגף |
| | حامل الدراجة للتثبيت على السقف |
| ZH | 頂置自行車架 |
| JA | ルーフマウント型サイクルキャリア |
| KO | 지붕 장착 자전거 캐리어 |
| TH | โครงยึดจับจักรยานแบบติดตั้งบนหลังคา |

HE
AR

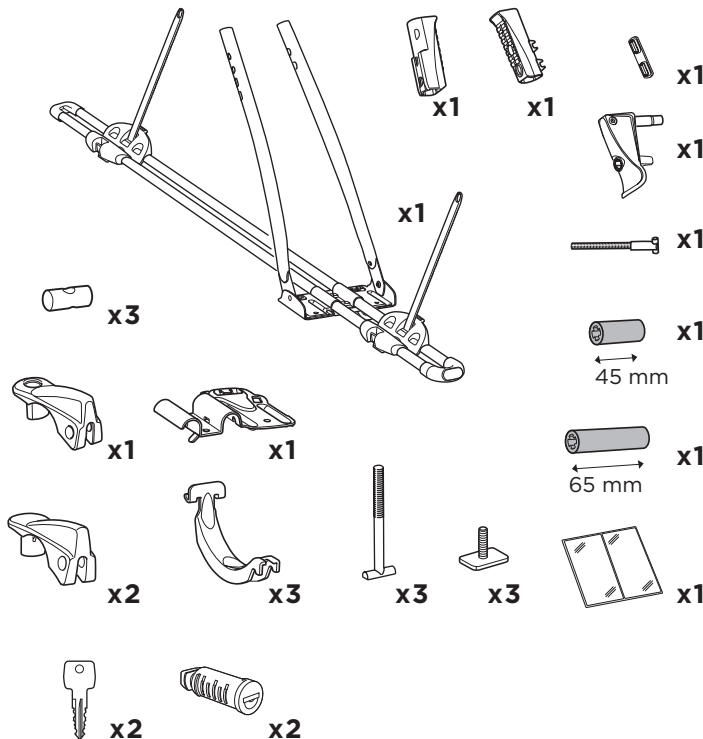
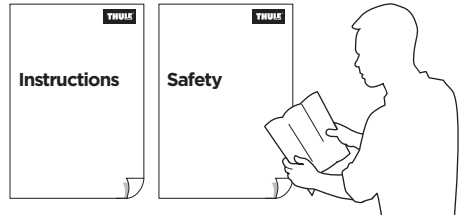

i



Thule WingBar Evo

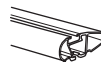

Thule WingBar

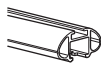

Thule AeroBar



Thule SlideBar

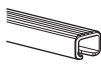

Thule SquareBar

i

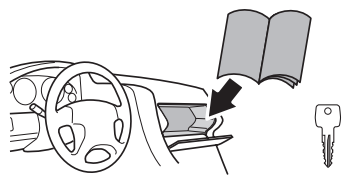
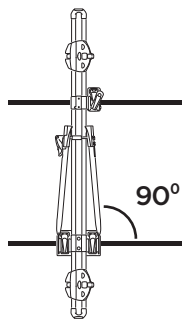
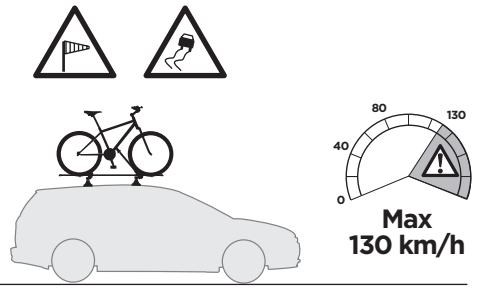
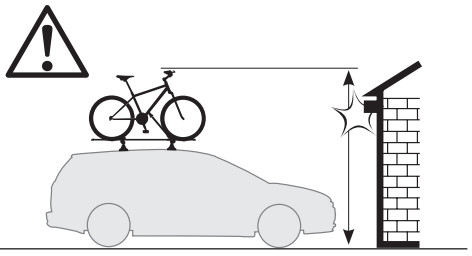
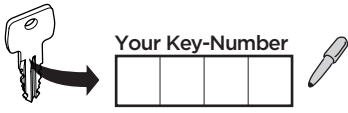

1

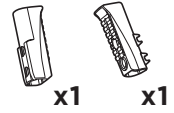
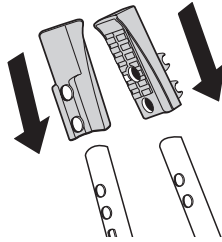

2



?

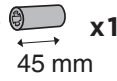

45 mm

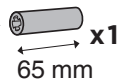

65 mm



x1



x1



x1



45 mm

Ø 22 - 58 mm

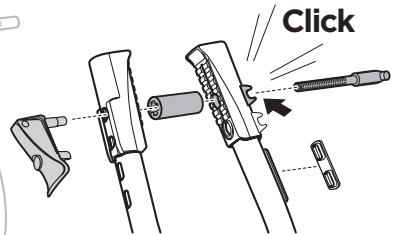
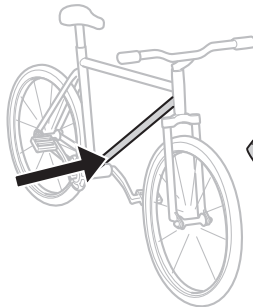

65 mm

Ø 59 - 70 mm

Max
65 x 80 mm

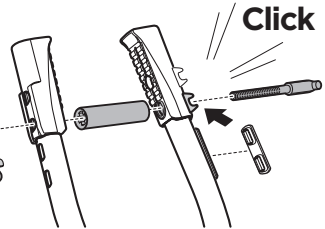
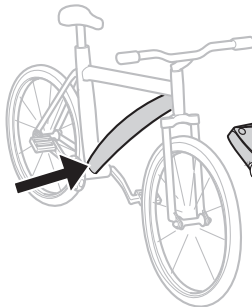

3

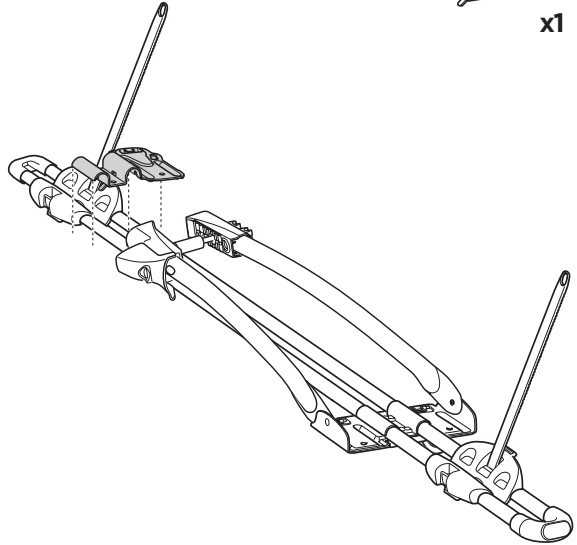
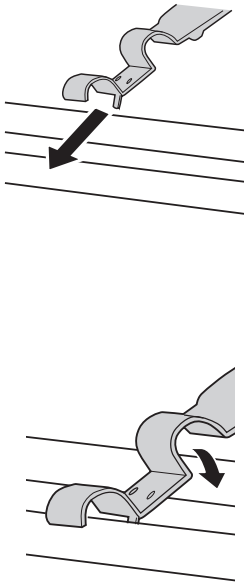

4

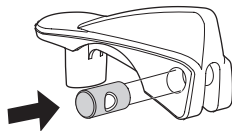
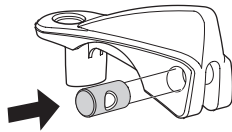

5

i

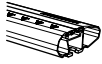

Thule WingBar Evo

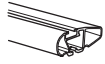

Thule WingBar



x1



x3

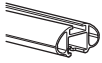

Thule AeroBar



Thule SlideBar



x2

A

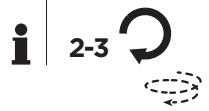
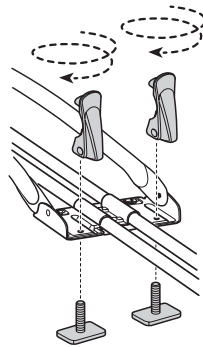
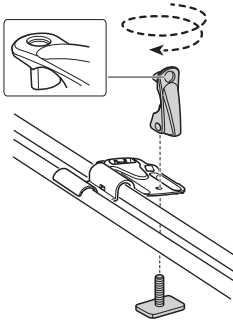

B

i



THULE WingBar Evo

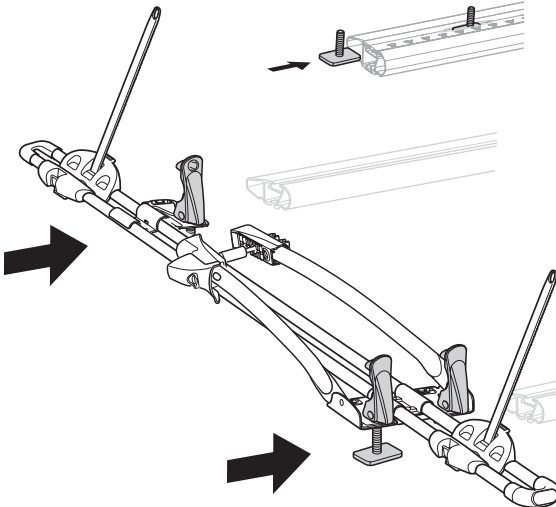
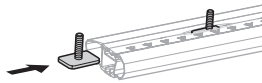

C

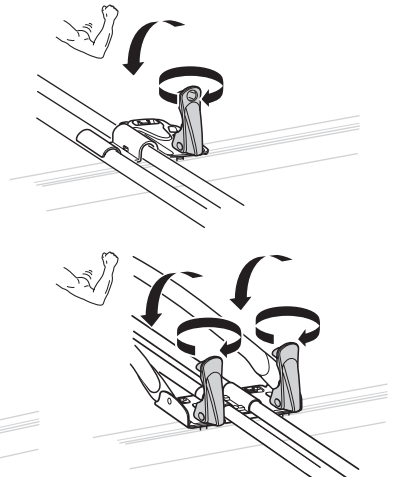

5

i



Thule SquareBar



x1



x3



x2



x3

A

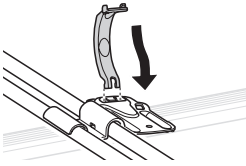

B

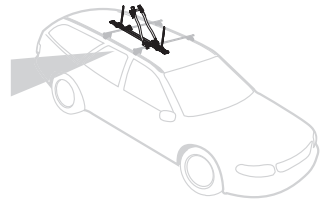
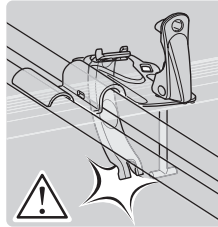
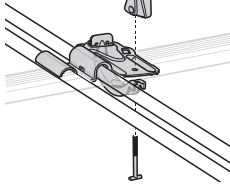

C

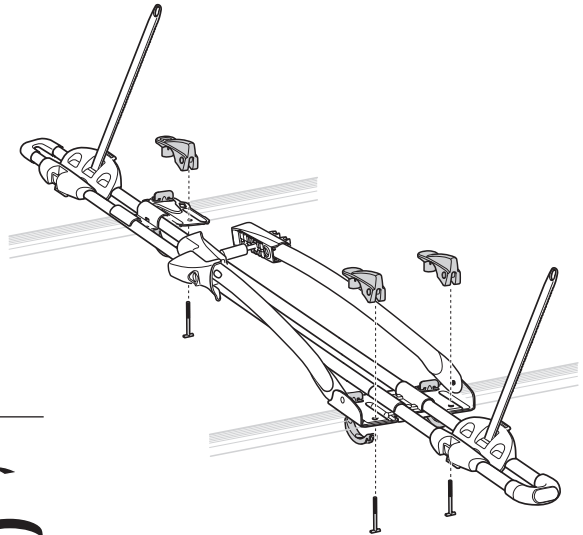
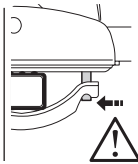
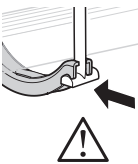

D



6

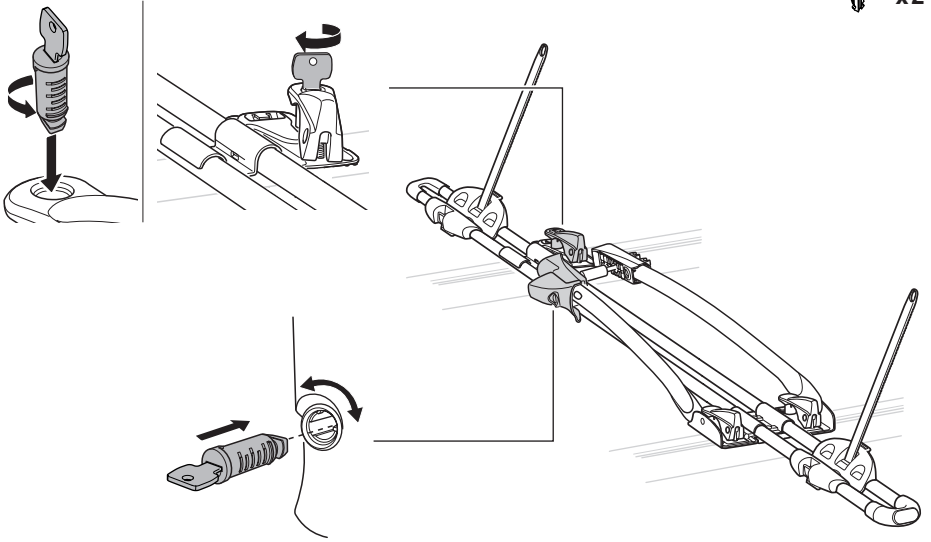

 x2

 x2

7

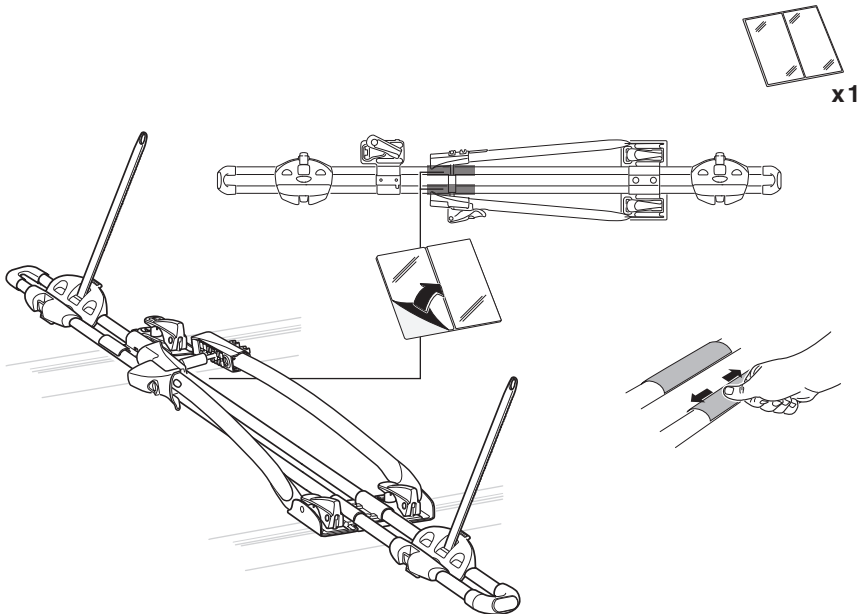

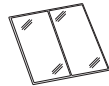
 x1

8

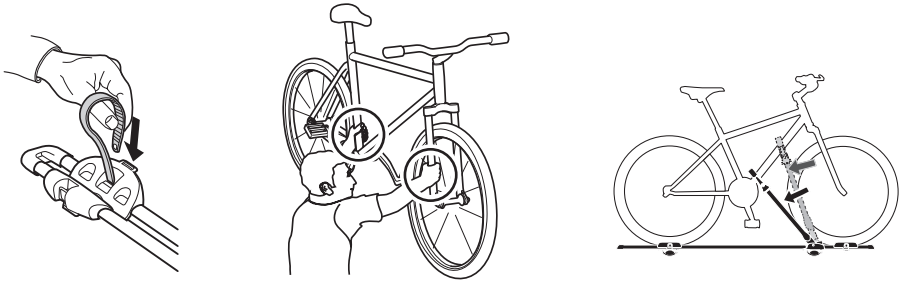

9

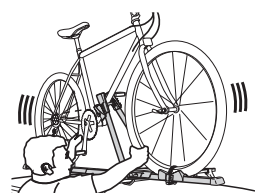
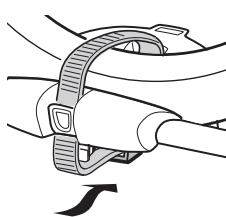
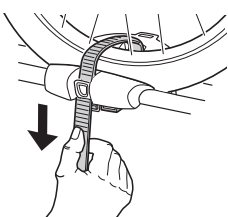
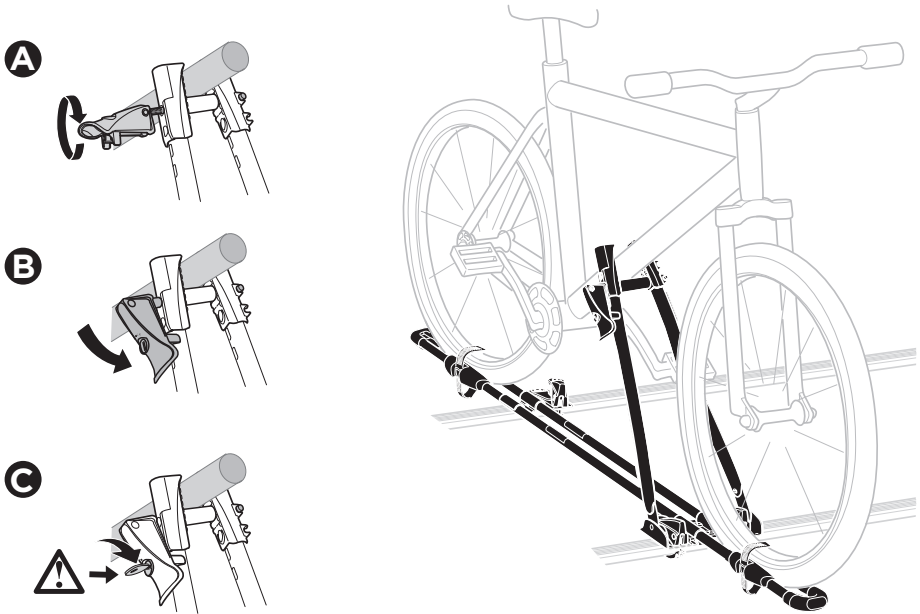

| | | | | |
|-----------|----------------------------|---------------|----------------------------|-----------|
| EN | Left-hand fitting | UK | Установка на ліву сторону | |
| DE | Montage links | BG | Монтаж отляво | |
| FR | Montage côté gauche | CS | Montáž z levé strany | |
| NL | Montage aan de linker kant | SK | Montáž na ľavej strane | |
| IT | Montaggio a sinistra | SL | Pritrjevanje z leve strani | |
| ES | Montaje a izquierda | HR/BIH | Montaža s lijeve strane | |
| PT | Montagem do lado esquerdo | RO | Montare pe partea stângă | |
| SV | Vänstermonterad | HU | Bal oldalról szerelhető | |
| DK | Venstremontering | EL | Τοποθέτηση αριστερά | |
| NO | Venstremontering | TR | Sol elle montaj | |
| FI | Asennus vasemmalle | | התקנה שמאלית | HE |
| ET | Vasakpoolne kinnitamine | | التركيب في الجانب الأيسر | AR |
| LV | Kreisais stiprinājums | ZH | 从左侧安装 | |
| LT | Kairysis pritvirtinimas | JA | 左手装着 | |
| PL | Montaż z lewej | KO | 왼손 장착 | |
| RU | Установка на левую сторону | TH | ตัวยึดด้านซ้ายมือ | |

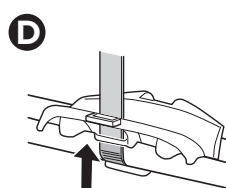
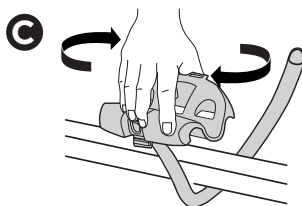
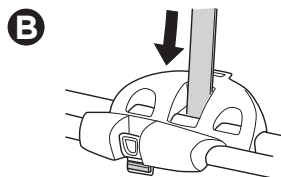
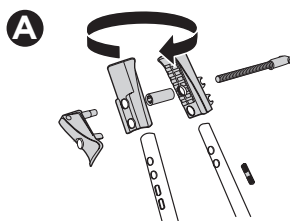
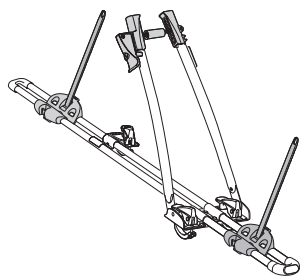

| | | | |
|-----------------------|-------------------------|--------------------------|------------------------|
| EN Accessories | DK Tilbehør | UK Аксессуары | EL Εξαρτήματα |
| DE Zubehör | NE Tilbehør | BG Принадлежности | TR Aksesuarlar |
| FR Accessoires | FI Lisävarusteet | CS Doplòky | الملحقات AR |
| NL Accessoires | ET Lisavarustus | SK Príslušenstvo | אביזרים HE |
| IT Accessori | LV Piederumi | SL Dodatki | ZH 附件 |
| ES Accesorios | LT Priedai | HR/BiH Dodaci | JA アクセサリー |
| PT Acessórios | PL Akcesoria | RO Accesorii | KO 액세서리 |
| SV Tillbehör | RU Аксессуары | HU Tartozékok | TH อุปกรณ์เสริม |

Thule One-Key System

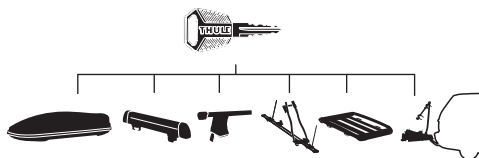

450400  (x4)

450600  (x6)

450800  (x8)

451200  (x12)

451600  (x16)

Thule Adapter 889-3

